

Nord

benker, stoler og bord

Design: C.F Møller Design Produsent: Veksø A/S

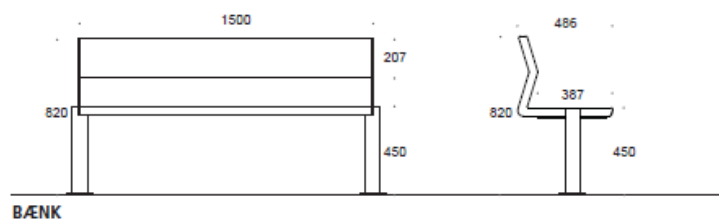

BÆNK

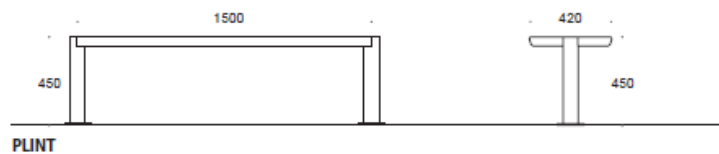

PLINT

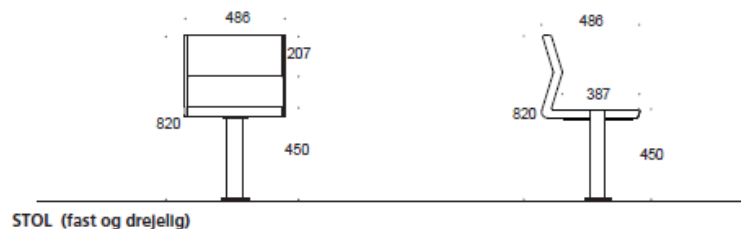

STOL (fast og drejelig)

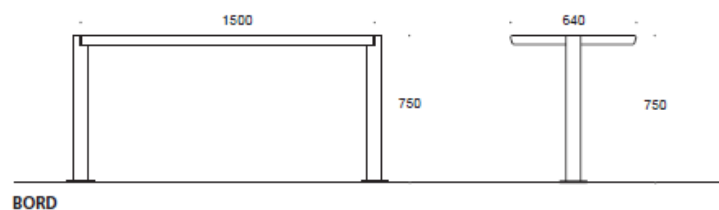

BORD



ARMLÆN

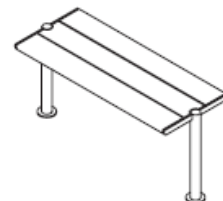
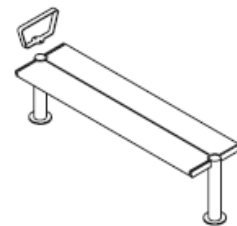
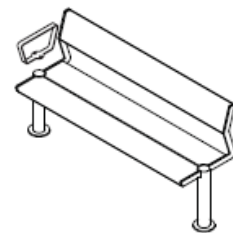

MONTERINGSVEILEDNING

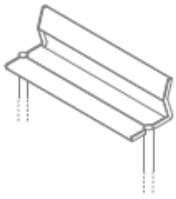

Bænk

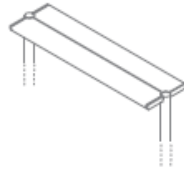

Plint



Bord



Stol (fast)



Stol (drejelig)

VEILEDNING FOR NEDSTØPING:

1 Afmærk placering af huller 

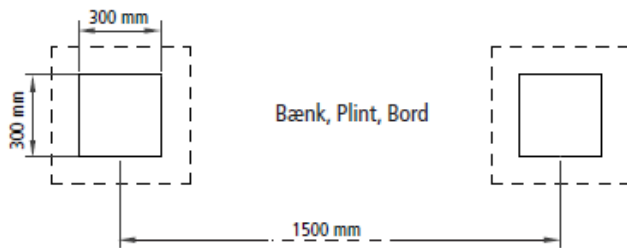
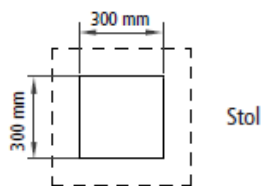

2 Grav ud til fundament 

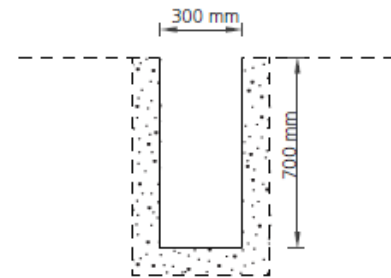

3 Støb benene fast

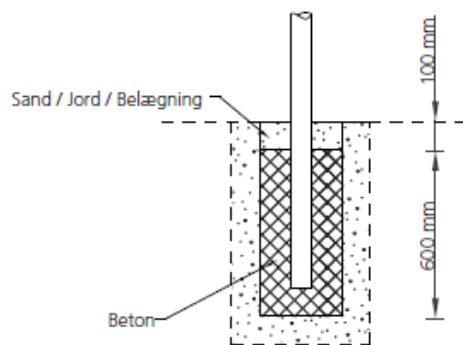

4

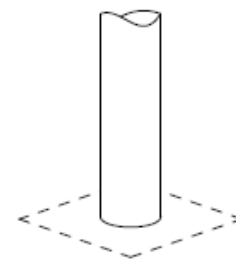

MONTERINGSVEILEDNING

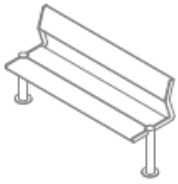

Bænk

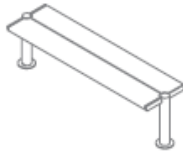

Plint



Bord



Stol (fast)



Stol (drejelig)

VEILEDNING FOR OVERFLATEMONTERING:

1 Afmærk placering af huller 

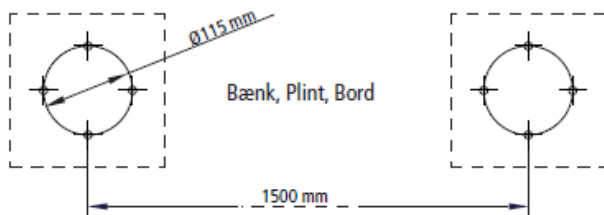
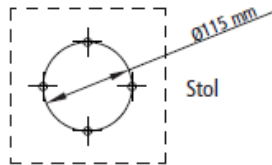

2 Bor huller 

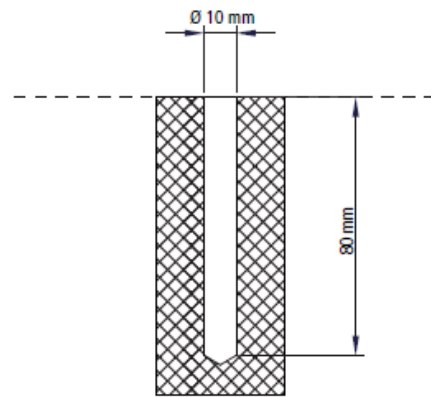

3 Påbolt bænken / plinten / bordet 

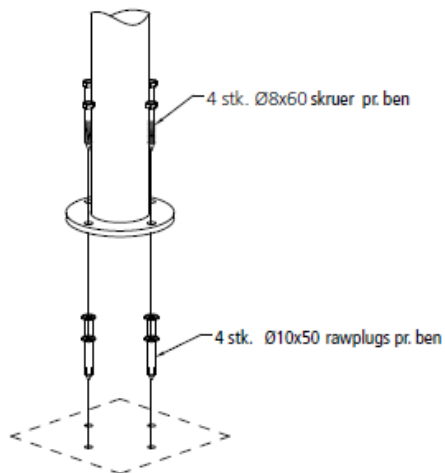

4

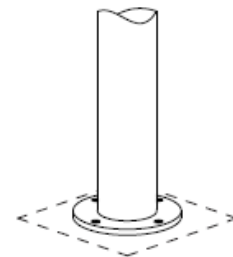

MONTERINGSVEILEDNING

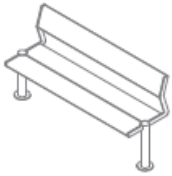

Bænk

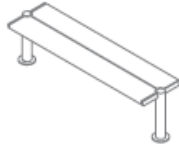

Plint



Stol (fast)



Stol (drejelig)

VEILEDNING FOR MONTERING AV ARMLENER:

